

## Grease separator EasyClean ground NS 7, Standard, 925-1215 mm, Class D

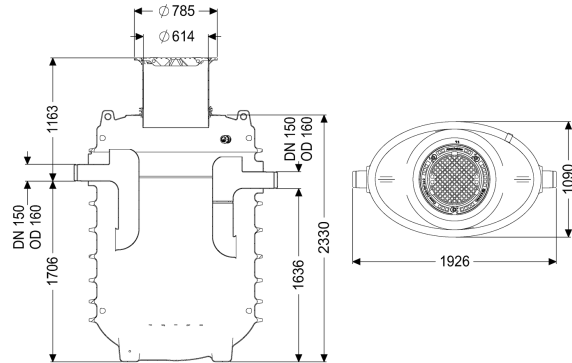

### Article information

Item no.: 95070-120D  
 GTIN: 4026092100424  
 Price group: 60

### Advantages

- Vertically adjustable upper section with odour-tight cover plates in various load classes
- Resistant to groundwater
- Low-maintenance operation

### Description

The separator for greasy wastewater is suitable for installation in the ground and comes without metallic structural components in the tank. The collecting tank made of permanently resistant polymer (PE) is equipped with an integrated sludge trap and has a rounded base for fast and clean disposal. Access for cleaning and maintenance work is possible via a service access cover.

Manual disposal is carried out with the tank open.

A load distribution slab must be installed on site for load class D. The reinforcement drawings are part of the EBA and are available from KESSEL.

The tank is groundwater resistant up to ground level (GL). 20 year polyethylene warranty.

#### Variant

Note on installation depth:	Installation in the ground, frost-free depth 1200 mm
Disposal variant:	Standard
Shredder-Mix-System:	no
Sludge bucket:	no
Nominal size (NS):	7,00
SonicControl:	no
Refill inlet in accordance with DIN 1988:	no
Type of disposal:	manual with suction hose
Load-bearing capacity (DIN 19901):	E4

### General characteristics

Material:	PE
Standard:	EN 1825
Installation situation:	underground installation
Delivery state:	Installation-ready (connection parts must be connected on site)

### Dimensions

Net weight:	315 kg
Gross weight:	380 kg
Installation depth:	925 - 1215 mm
Type of height adjustability:	vertically adjustable upper section, can be tilted by 5 degrees
Length:	1870 mm
Width:	1090 mm
Height:	2375 mm
Packaging dimension:	length
Packaging dimension:	width
Packaging dimension:	height

### Tank/drain body

Distance pipe bottom outlet to tank bottom:	1635 mm
Distance pipe bottom inlet to tank bottom:	1705 mm
Outlet nominal size (OD):	160 mm
Outlet nominal size (DN):	150 mm
Inlet nominal size (OD):	160 mm
Inlet nominal size (DN):	150 mm
Connection inlet/outlet sockets:	PE-HD pipes in accordance with DIN 19537, PVC-KG pipes in accordance with DIN 19534, PP or AS
Clear width of entry (LW):	600 mm

### Coverage features

Type of cover:	Cover plate
Cover material:	Grey iron
Colour of cover:	black
Locking:	Lock & Lift
Load class:	D 400 (EN 124)
Tightness:	odour-tight and surface water resistant

### Wastewater contents

Separator contents:	930 l
Max. grease layer thickness:	270 mm
Total volume:	1630 l
Contents of sludge trap:	700 l
Storage quantity of grease:	280 l

### Control

Control unit:	no
---------------	----