

## Grease separator EasyClean ground NS 1, Direct, 1190-1740 mm, D, left

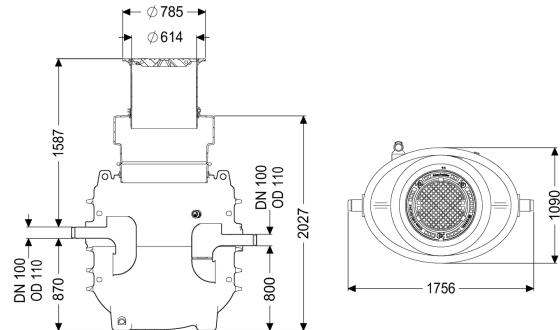

### Article information

Item no.: 95010-170D-DL  
 GTIN: 4026092101186  
 Price group: 60

### Advantages

- Low odour and clean disposal
- Defined disposal point
- Complete emptying of the separator

### Description

The separator for greasy wastewater is suitable for installation in the ground and comes without metallic structural components in the tank. The collecting tank made of permanently resistant polymer (PE) is equipped with an integrated sludge trap, and has a rounded base for fast and clean disposal. Access for cleaning and maintenance work is possible via a service access cover. A direct disposal pipe socket is available for manual disposal. A load distribution slab must be installed on site for load class D. The reinforcement drawings are part of the EBA and are available from KESSEL. The tank is groundwater resistant up to ground level (GL). 20 year polyethylene warranty.

#### Variant

|                                    |  |
|------------------------------------|--|
| Note on installation depth:        | Ground installation frost-free depth 1700 mm |
| Direction of flow:                 | left   |
| Disposal variant:                  | Direct                                       |
| Nominal size (NS):                 | 1,00   |
| Disposal system:                   | Disposal pipe                                |
| Type of disposal:                  | manual                                       |
| Load-bearing capacity (DIN 19901): | E4   |

#### General characteristics

|                         |                          |
|-------------------------|--------------------------|
| Material:               | PE                       |
| Standard:               | EN 1825                  |
| Installation situation: | underground installation |

|   |   |
|---|---|
| Delivery state:                             | Installation-ready (connection parts must be connected on site)                               |
| <b>Dimensions</b>                           |   |
| Net weight:                                 | 245 kg  |
| Gross weight:                               | 245 kg  |
| Diameter:                                   | 648 mm  |
| Installation depth:                         | 1190 - 1740 mm  |
| Length:                                     | 1700 mm   |
| Width:                                      | 1090 mm   |
| Height:                                     | 1515 mm   |
| Packaging dimension:                        | length  |
| Packaging dimension:                        | width   |
| Packaging dimension:                        | height  |
| <b>Tank/drain body</b>                      |   |
| Distance pipe bottom outlet to tank bottom: | 800 mm  |
| Distance pipe bottom inlet to tank bottom:  | 870 mm  |
| Outlet nominal size (DN):                   | 100 mm  |
| Inlet nominal size (OD):                    | 110 mm  |
| Inlet nominal size (DN):                    | 100 mm  |
| Connection inlet/outlet sockets:            | PE-HD pipes in accordance with DIN 19537, PVC-KG pipes in accordance with DIN 19534, PP or AS |
| Clear width of entry (LW):                  | 600 mm  |
| <b>Coverage features</b>                    |   |
| Type of cover:                              | Cover plate   |
| Cover material:                             | Grey iron   |
| Colour of cover:                            | black   |
| Locking:                                    | Lock & Lift   |
| Load class:                                 | D 400 (EN 124)  |
| Tightness:                                  | odour-tight and surface water resistant   |
| <b>Wastewater contents</b>                  |   |
| Separator contents:                         | 550 l   |
| Max. grease layer thickness:                | 42 mm   |
| Total volume:                               | 650 l   |
| Contents of sludge trap:                    | 100 l   |
| Storage quantity of grease:                 | 40 l  |