

Controlfix clean out DN 150, Floor slab, black

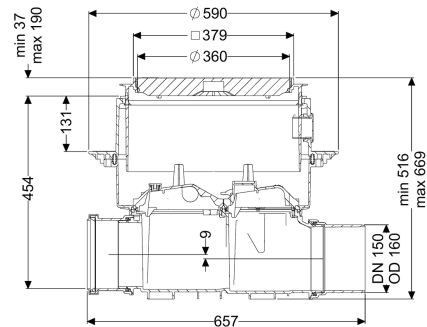

Article information

Item no.: 80150S
 GTIN: 4026092004098
 Price group: 30

Advantages

- Simple conversion to Staufix SWA
- Fast, simple and toolless maintenance
- Quick and toolless access for cleaning

Description

The Premium clean out for faecal and faecal-free wastewater makes easy access to wastewater pipes possible for inspection and maintenance work. Thanks to the modular KESSEL system, existing systems can easily be converted to a Staufix SWA Premium backwater valve, Staufix FKA or Pumpfix F backwater pumping station.

General characteristics

Colour:	black
Nominal size (DN):	150
Outer diameter (OD):	160 mm
Type of wastewater:	for wastewater with and without sewage
Installation situation:	floor slab installation
Delivery state:	Installation-ready (connection parts must be connected on site)

Dimensions

Net weight:	14 kg
Gross weight:	17,32 kg
Groundwater resistant from lower edge of base section:	3000 mm
Cutout dimension, width:	750 mm
Cutout dimension, length:	750 mm
Vertical drop between inlet and outlet:	9 mm
Installation depth:	516 - 669 mm
Type of height adjustability:	vertically adjustable upper section
Length:	486 mm

Width:	590 mm
Packaging dimension:	length
Packaging dimension:	width
Packaging dimension:	height
Tank/drain body	
Socket version:	including spigot and socket
Coverage features	
Type of cover:	Cover plate
Cover material:	Polymer
Colour of cover:	black
Width of cover:	366 mm
Length of cover:	366 mm
Locking:	Lock & Lift
Load class:	L 15 (EN 1253-1)
Tightness:	surface water resistant