

Box channel Ferrofix glued flange H: 15mm, 300x550mm

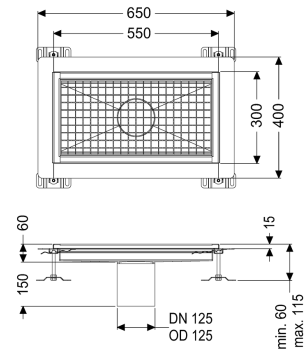

Article information

Item no.: 6030050
 GTIN: 4026092066478
 Price group: 80

Advantages

- Made of particularly a hygienic and mechanically highly resistant stainless steel
- Variably combinable with suitable drain bodies

Description

The Ferrofix box channel made of stainless steel with a material thickness of 2.0 mm (pickled in the immersion bath) is equipped with polished visible ridges, longitudinal and transverse slopes, feet for height adjustment and stainless steel outlet nozzles. The channel profile is suitable for joint sealing and has a circumferential adhesive edge (15 mm deep and 50 mm folded outwards) with welded mitres. The glued flange is suitable for connecting waterproofing layers in accordance with DIN 18534, for all waterproofing classes.

Variant

Waterproofing layer on the upper section:	Adhesive flange (suitable for moisture barriers)
Water exposure class in accordance to DIN 18534-1 (up to and including):	W3-I

General characteristics

Nominal size (DN):	125
Outer diameter (OD):	125 mm
Glued flange height:	15 mm
ATEX:	no

Dimensions

Net weight:	9 kg
Gross weight:	9 kg
Length:	550 mm
Width:	300 mm
Height:	60 mm

Packaging dimension:	length
Packaging dimension:	width
Packaging dimension:	height
Coverage features	
Type of cover:	Slotted cover
Colour of cover:	silver
Locking:	placed
Load class:	L 15 (EN 1253-1)
Slip resistance class:	R12 according to DIN 51130; C according to DIN 51097
Upper section material:	Stainless steel 14301